



## 240W Constant Voltage + Constant Current LED Driver **HBG-240P** series



### ■ Features

- Constant Voltage + Constant Current mode output
- Circular shape PCB type design
- Built-in active PFC function
- Function options: output adjustable via potentiometer;  
3 in 1 dimming
- Typical lifetime > 50000 hours
- 5 years warranty

### ■ Applications

- LED bay lighting
- LED down lighting
- LED spot lighting
- LED mining lighting
- LED stage lighting

### ■ Description

HBG-240P series is a 240W AC/DC PCB type LED driver featuring the circular shape design. It operates from 90~305VAC and offers the dual mode constant voltage and constant current output models with different rated voltage ranging between 36V and 60V. Thanks to the high efficiency up to 93.5%, with the fanless design, the entire series is able to operate for -40°C ~ +45°C under free air convection. HBG-240P is equipped with various function options, such as dimming methodology, so as to provide the optimal design flexibility for LED lighting system.

### ■ Model Encoding

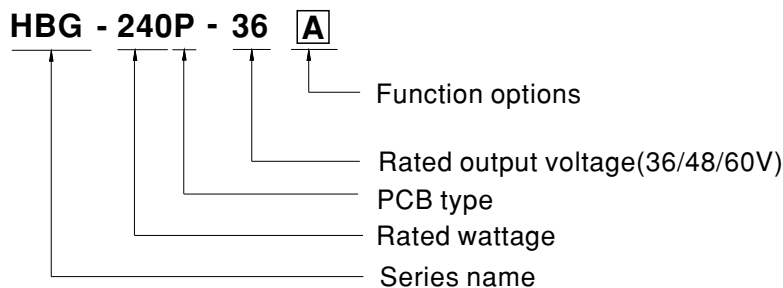

| Type | Function   | Note     |
|------|--|----------|
| A    | Io adjustable through built-in potentiometer.                    | In Stock |
| B    | 3 in 1 dimming function (1~10Vdc, 10V PWM signal and resistance) | In Stock |



# 240W Constant Voltage + Constant Current LED Driver **HBG-240P** series

## SPECIFICATION

| MODEL                                  |   | HBG-240P-36 <input type="checkbox"/>  | HBG-240P-48 <input type="checkbox"/> | HBG-240P-60 <input type="checkbox"/> |
|--|---|---|--------------------------------------|--------------------------------------|
| OUTPUT                                 | DC VOLTAGE  | 36V   | 48V                                  | 60V                                  |
|  | CONSTANT CURRENT REGION <small>Note.2</small>   | 21.6 ~ 36V  | 28.8 ~ 48V                           | 36 ~ 60V                             |
|  | RATED CURRENT   | 6.7A  | 5A                                   | 4.0A                                 |
|  | RATED POWER <small>Note.5</small>   | 241.2W  | 240W                                 | 240W                                 |
|  | RIPPLE & NOISE (max.) <small>Note.3</small>   | 250mVp-p  | 250mVp-p                             | 350mVp-p                             |
|  | CURRENT ADJ. RANGE  | Adjustable for A-Type only (via built-in potentiometer)   |                                      |                                      |
|  |   | 4.0 ~ 6.7A  | 3 ~ 5A                               | 2.4 ~ 4.0A                           |
|  | VOLTAGE TOLERANCE <small>Note.4</small>   | ±2.0%   |                                      |                                      |
|  | LINE REGULATION   | ±0.5%   |                                      |                                      |
|  | LOAD REGULATION   | ±0.5%   |                                      |                                      |
| SETUP, RISE TIME <small>Note.6</small> | 2500ms, 120ms / 115VAC  | 500ms, 120ms / 230VAC   |                                      |                                      |
| HOLD UP TIME (Typ.)                    | 15ms/115VAC, 230VAC   |   |                                      |                                      |
| INPUT                                  | VOLTAGE RANGE <small>Note.5</small>   | 90 ~ 305VAC    127 ~ 431VDC<br>(Please refer to "STATIC CHARACTERISTIC" section)  |                                      |                                      |
|  | FREQUENCY RANGE   | 47 ~ 63Hz   |                                      |                                      |
|  | POWER FACTOR  | PF ≥ 0.98/115VAC, PF ≥ 0.94/230VAC, PF ≥ 0.9/277VAC@full load<br>(Please refer to "POWER FACTOR (PF) CHARACTERISTIC" section) |                                      |                                      |
|  | TOTAL HARMONIC DISTORTION   | THD < 20% (@load ≥ 60%/115VAC, 230VAC; @load ≥ 75%/277VAC)<br>(Please refer to "TOTAL HARMONIC DISTORTION (THD)" section)     |                                      |                                      |
|  | EFFICIENCY (Typ.)   | 92.5%   | 93%                                  | 93.5%                                |
|  | AC CURRENT  | 2.8A / 115VAC   | 1.4A / 230VAC                        | 1.2A / 277VAC                        |
|  | INRUSH CURRENT (Typ.)   | COLD START 75A (width=680μs measured at 50% Ipeak) at 230VAC; Per NEMA 410  |                                      |                                      |
|  | MAX. No. of PSUs on 16A CIRCUIT BREAKER   | 2 units (circuit breaker of type B) / 3 units (circuit breaker of type C) at 230VAC   |                                      |                                      |
| LEAKAGE CURRENT                        | <0.75mA / 277VAC  |   |                                      |                                      |
| PROTECTION                             | OVER CURRENT  | 95 ~ 108%<br>Constant current limiting, recovers automatically after fault condition is removed                               |                                      |                                      |
|  | SHORT CIRCUIT   | Hiccup mode, recovers automatically after fault condition is removed.   |                                      |                                      |
|  | OVER VOLTAGE  | 43 ~ 52V  | 52 ~ 63V                             | 62 ~ 85V                             |
|  |   | Shut down and latch off o/p voltage, re-power on to recover   |                                      |                                      |
|  | OVER TEMPERATURE  | Shut down o/p voltage, recovers automatically after temperature goes down   |                                      |                                      |
| ENVIRONMENT                            | WORKING TEMP.   | Ta = -40 ~ +45°C (Please refer to "OUTPUT LOAD vs TEMPERATURE" section)   |                                      |                                      |
|  | WORKING HUMIDITY  | 20 ~ 95% RH non-condensing  |                                      |                                      |
|  | STORAGE TEMP., HUMIDITY   | -40 ~ +80°C, 10 ~ 95% RH  |                                      |                                      |
|  | TEMP. COEFFICIENT   | ±0.03%/°C (0 ~ 50°C)  |                                      |                                      |
|  | VIBRATION   | 10 ~ 500Hz, 2G 12min./1cycle, period for 72min. each along X, Y, Z axes   |                                      |                                      |
| SAFETY & EMC                           | SAFETY STANDARDS  | UL8750, CSA C22.2 No.250.13-12; ENEC EN61347-1, EN61347-2-13, EN62384, GB19510.1, GB19510.14 approved                         |                                      |                                      |
|  | WITHSTAND VOLTAGE   | I/P-O/P: 3.75KVAC    I/P-FG: 2KVAC    O/P-FG: 0.5KVAC   |                                      |                                      |
|  | ISOLATION RESISTANCE  | I/P-O/P, I/P-FG, O/P-FG: 100M Ohms / 500VDC / 25°C / 70% RH   |                                      |                                      |
|  | EMC EMISSION  | Compliance to EN55015, EN55022 (CISPR22) Class B, EN61000-3-2 Class C (@load ≥ 75%); EN61000-3-3, GB17743, GB17625.1          |                                      |                                      |
|  | EMC IMMUNITY  | Compliance to EN61000-4-2, 3, 4, 5, 6, 8, 11, EN61547, light industry level (surge immunity: Line-Earth: 4KV, Line-Line: 2KV) |                                      |                                      |
| OTHERS                                 | MTBF  | 175Khrs min.    MIL-HDBK-217F (25°C)  |                                      |                                      |
|  | DIMENSION   | Refer to mechanical specification   |                                      |                                      |
|  | PACKING   | 0.62Kg; 20pcs/13.4Kg/1.11CUFT   |                                      |                                      |
| NOTE                                   | <ol style="list-style-type: none"> <li>All parameters NOT specially mentioned are measured at 230VAC input, rated current and 25°C of ambient temperature.</li> <li>Please refer to "DRIVING METHODS OF LED MODULE".</li> <li>Ripple &amp; noise are measured at 20MHz of bandwidth by using a 12" twisted pair-wire terminated with a 0.1uf &amp; 47uf parallel capacitor.</li> <li>Tolerance : includes set up tolerance, line regulation and load regulation.</li> <li>De-rating may be needed under low input voltages. Please refer to "STATIC CHARACTERISTIC" sections for details.</li> <li>Length of set up time is measured at first cold start. Turning ON/OFF the driver may lead to increase of the set up time.</li> <li>The driver is considered as a component that will be operated in combination with final equipment. Since EMC performance will be affected by the complete installation, the final equipment manufacturers must re-qualify EMC Directive on the complete installation again.</li> <li>To fulfill requirements of the latest ErP regulation for lighting fixtures, this LED driver can only be used behind a switch without permanently connected to the mains.</li> <li>This series meets the typical life expectancy of &gt;50,000 hours of operation when Ta is about 45°C or less.</li> <li>Please refer to the warranty statement on MEAN WELL's website at <a href="http://www.meanwell.com">http://www.meanwell.com</a></li> </ol> |   |                                      |                                      |



## 240W Constant Voltage + Constant Current LED Driver **HBG-240P** series

### ■ BLOCK DIAGRAM

fosc : 100KHz

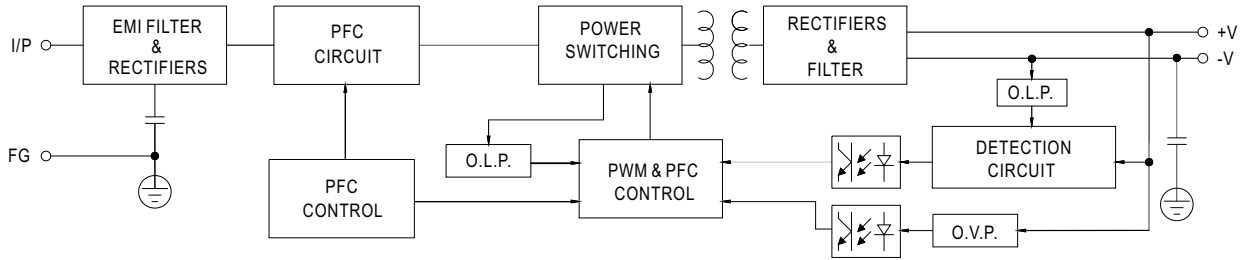

### ■ DRIVING METHODS OF LED MODULE

※ This series is able to work in either Constant Current mode (a direct drive way) or Constant Voltage mode (usually through additional DC/DC driver) to drive the LEDs.

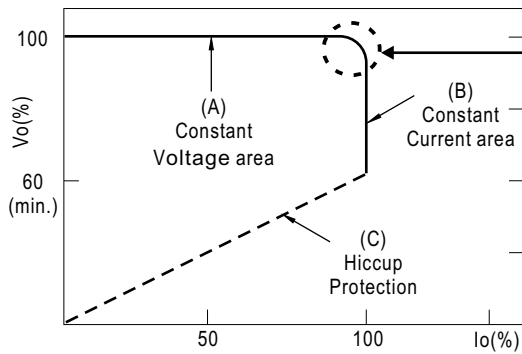

Typical output current normalized by rated current (%)

In the constant current region, the highest voltage at the output of the driver depends on the configuration of the end systems.  
Should there be any compatibility issues, please contact MEAN WELL.

## ■ DIMMING OPERATION

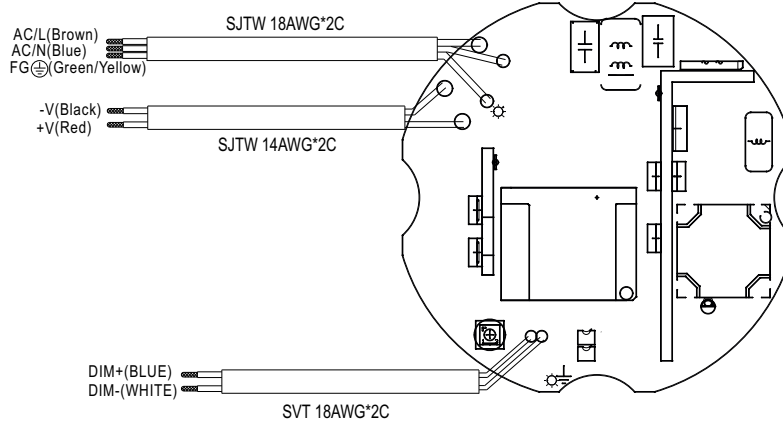

### ※ 3 in 1 dimming function (for B-Type)

- Output constant current level can be adjusted by applying one of the three methodologies between DIM+ and DIM-:  
1 ~ 10VDC, or 10V PWM signal or resistance.
- Direct connecting to LEDs is suggested. It is not suitable to be used with additional drivers.
- Dimming source current from power supply: 100 $\mu$ A (typ.)

#### ◎ Applying additive 1 ~ 10VDC

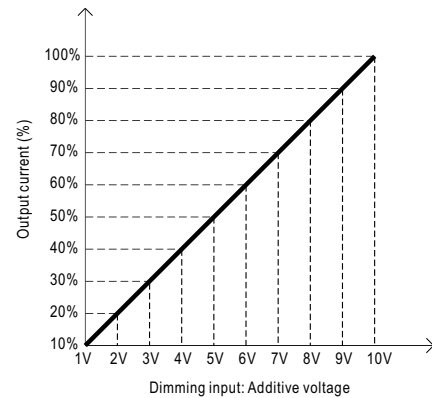
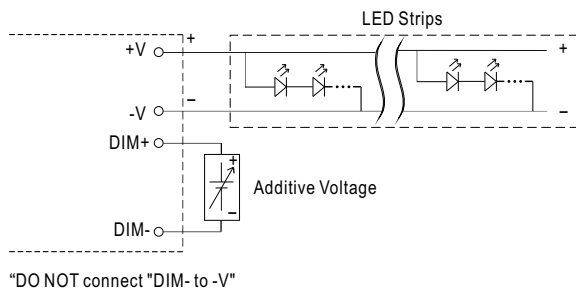

#### ◎ Applying additive 10V PWM signal (frequency range 100Hz ~ 3KHz):

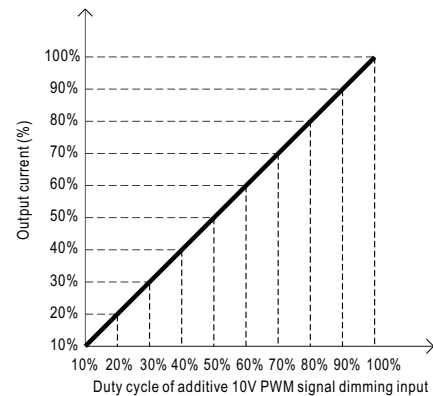
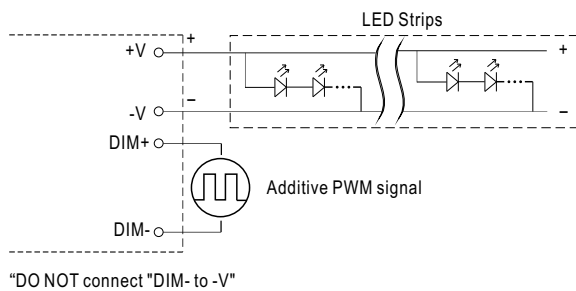



# 240W Constant Voltage + Constant Current LED Driver **HBG-240P** series

◎ Applying additive resistance:

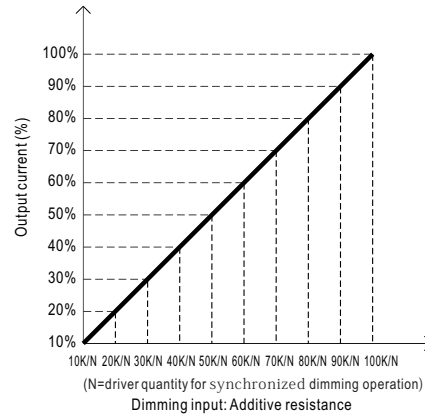
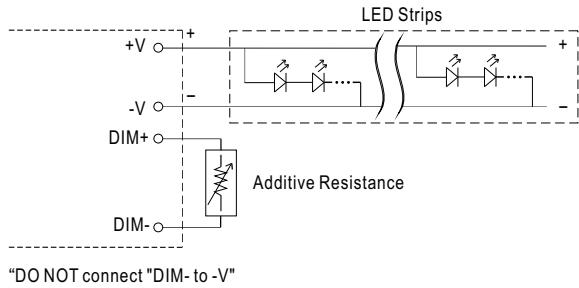

Note: In the case of turning the lighting fixture down to 0% brightness, please refer to the configuration as follow, or please contact MEAN WELL for other options.

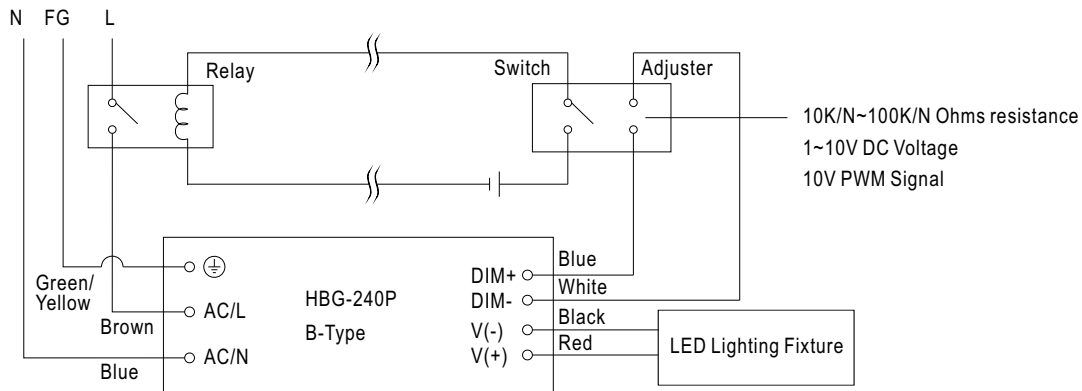

Using a switch and relay can turn ON/OFF the lighting fixture.

### OUTPUT LOAD vs TEMPERATURE

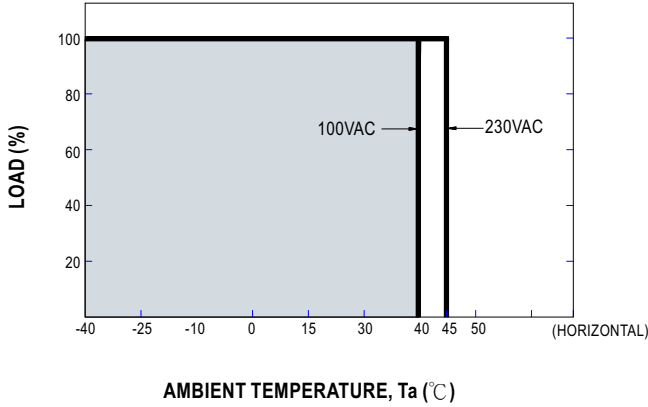

### STATIC CHARACTERISTIC

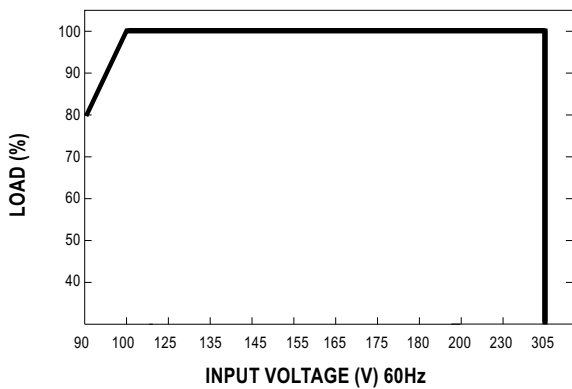

※ De-rating is needed under low input voltage.

### POWER FACTOR (PF) CHARACTERISTIC

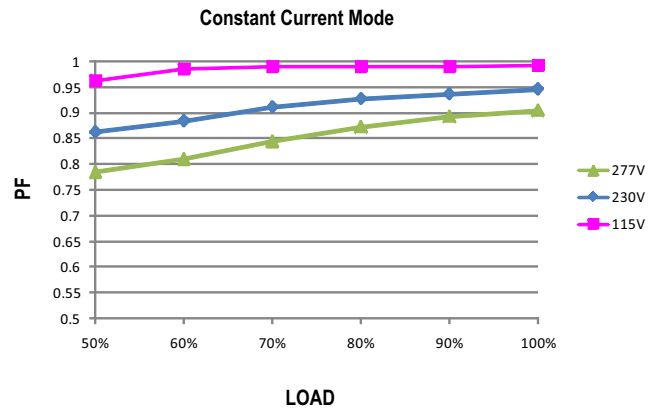

### TOTAL HARMONIC DISTORTION (THD)

※ 60V Model

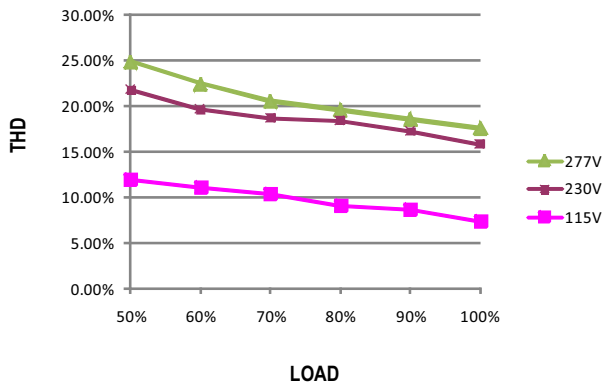

### EFFICIENCY vs LOAD

HBG-240P series possess superior working efficiency that up to 93.5% can be reached in field applications.

※ 60V Model

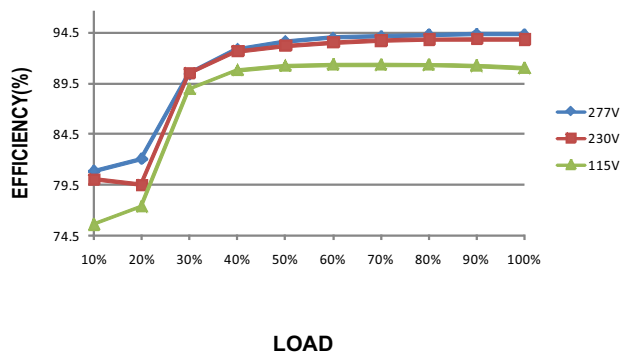



# 240W Constant Voltage + Constant Current LED Driver **HBG-240P** series

## MECHANICAL SPECIFICATION

※ **A-type**

Unit:mm

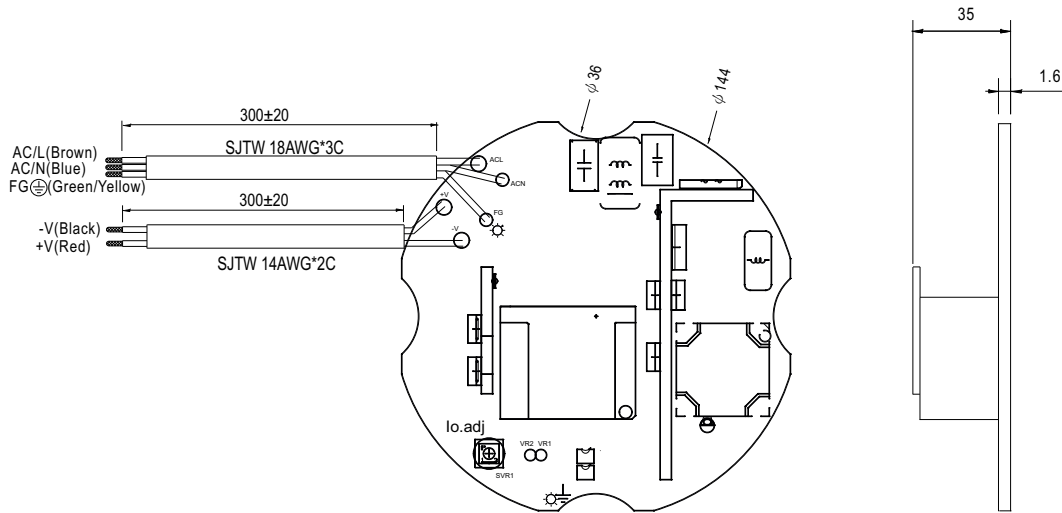

※ **B-type**

